

Edges and fixing systems
Gyptone ceilings
3.2.4 Trap system

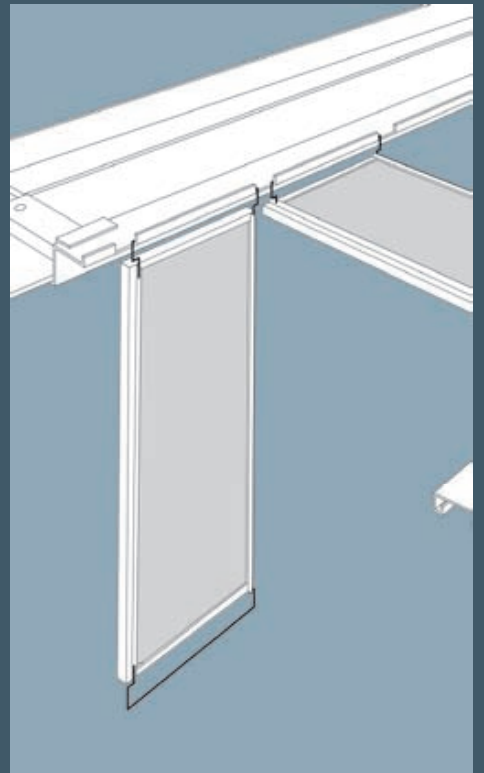
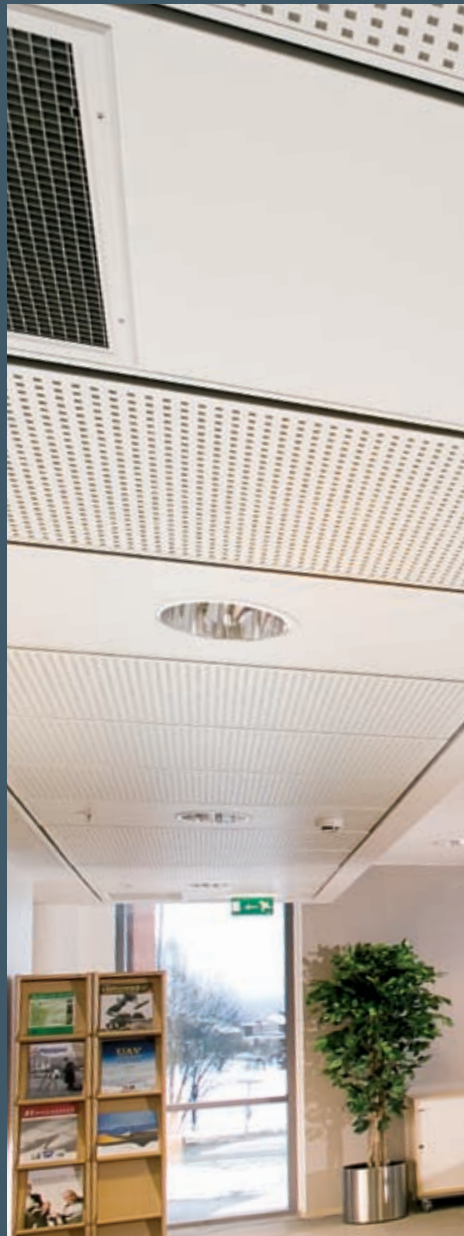

Gyptone®

Reflecting everyday life

Trap system

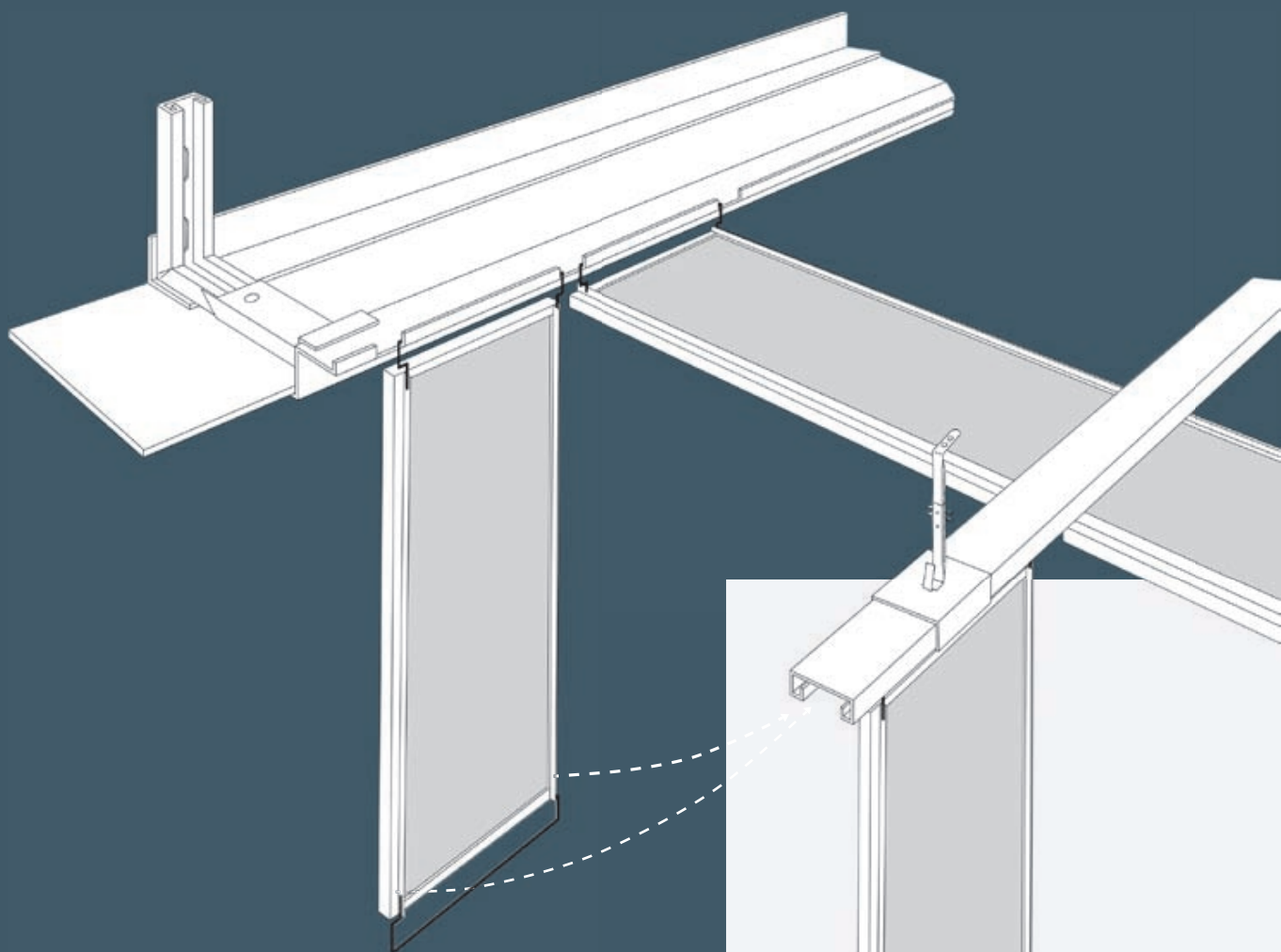

Gyptone Trap is a special ceiling system which gives very good access possibilities to concealed installations. Trap units comprise pre-painted Gyptone tiles completed with a white-lacquered steel frame.

The system also includes sections for connection to direct friezes and along corridor walls. The Trap unit can be let down to either side and be allowed to hang freely to give convenient access to services along the entire corridor.

Units

The system consists of several units which can be combined in different ways.

This flexibility means that the system can be tailored to each individual project.

For more information about installation possibilities and details of solutions contact Gyproc.

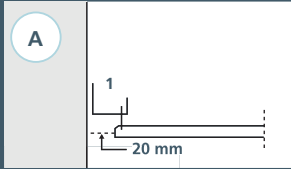

Trap units with:
Wall Profile, direct

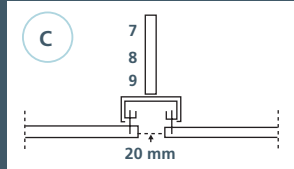

Centre Profile

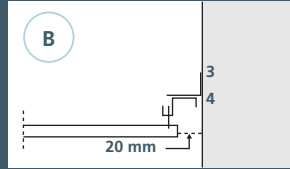

Wall Profile, adjustable

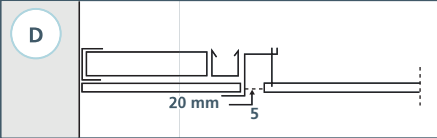

Trap unit with Frieze Profile

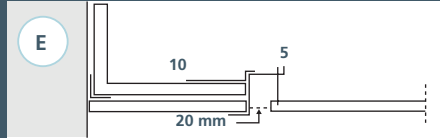

Direct Frieze installed with adjustable
bracket and Trap Frieze Profile

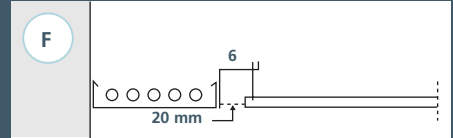

Trap Units mounted against cable tray
Profile

Upon ordering one can make reference to solutions



- 1 Trap Wall Profile, direct
L: 2400 mm

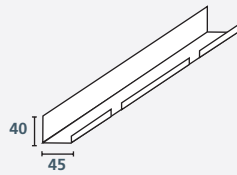

- 2 Trap Coupling Fitting
– for Wall Profile,
adjustable

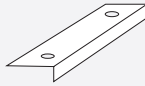

- 3 Trap Wall Angle, adjustable
80 x 50 x 40 mm

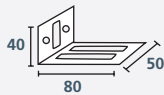

- 4 Trap Wall Profile, adjustable
L: 2400 mm

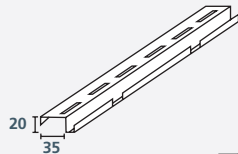

- 5 Trap Frieze Profile
L: 2400 mm

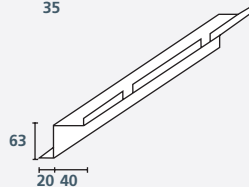

- 6 Trap Cable chute Profile
L: 2400 mm

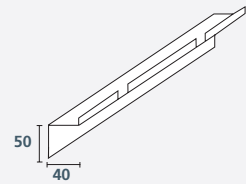

- 7 Trap hanger
– 240, 440, 640 og 940

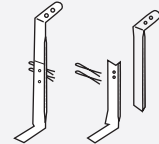

- 8 Trap Suspension
for Centre Profile

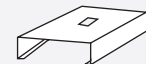

- 9 Trap Centre Profile
L: 2400 mm

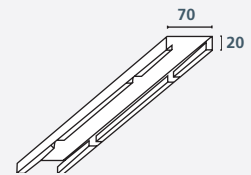

- 10 Trap bracket, adjustable
250, 350 og 500

250: adjustable from 250 – 350 mm
350: adjustable from 350 – 450 mm
500: adjustable from 500 – 600 mm

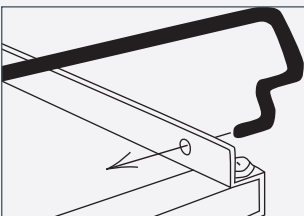
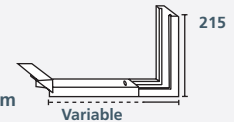

The Trap unit is supplied with separate master hangers. The units have pre-drilled holes into which the master hangers are fixed before the Trap unit is ready to be mounted.

More information can be found on
www.gyptone.com

www.gyptone.com

Gyptone.com is not just a home page. Here you can find all Gyptone products "live" – see www.gyptone.com – choose the 3D product gallery and you will enter a 3D universe where all our products can be turned around and over, put together with different systems and displayed exactly the way you want them in your project.



Gyproc A/S
Hareskovvej 12
DK-4400 Kalundborg
Denmark
Tel.: +45 59 57 03 30
Fax: +45 59 57 03 01
e-mail: info@gyproc.com
www.gyptone.com

October 2007

